

Asa para fechos de embutir p/ séries convencionais
 Handle for for lateral closing gears for conventional series
 Tiradores sobrepuesto cierre de embutir s. convencionales
 Poignée de tirage pour fermeture latérale s. conventionelle

Fechos de correr



200

Maquinação # Machining # Mecanizado # Usinage

ALPHA

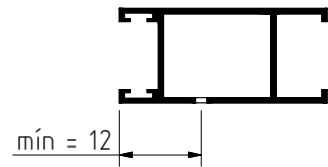
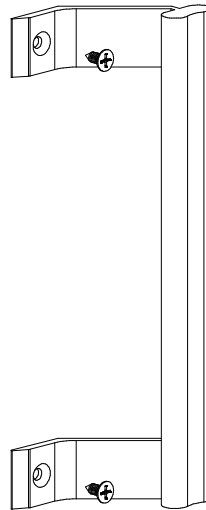
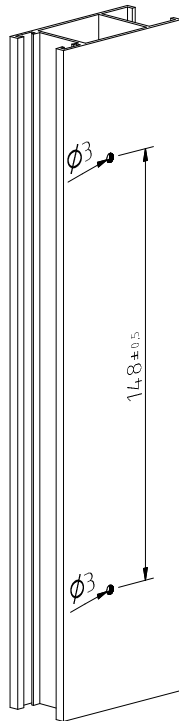
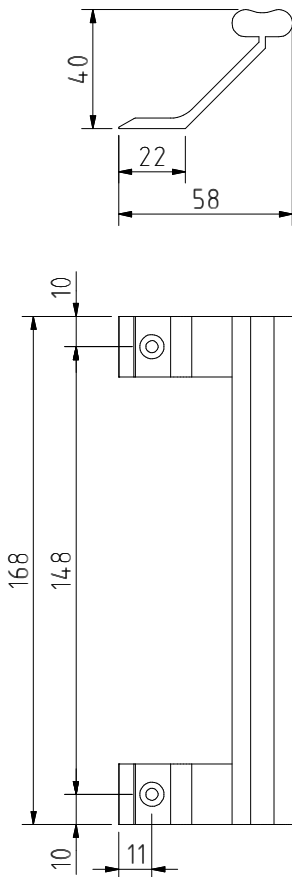

Montagem # Assembly # Montaje # Assemblage

Compatibilidade # Compatibility #
 Compatibilidad # Compatibilité

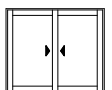
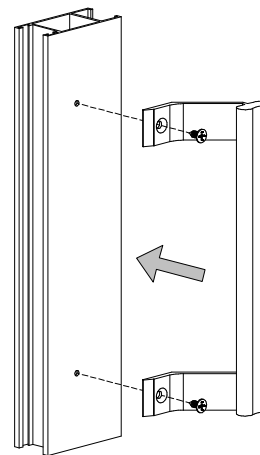
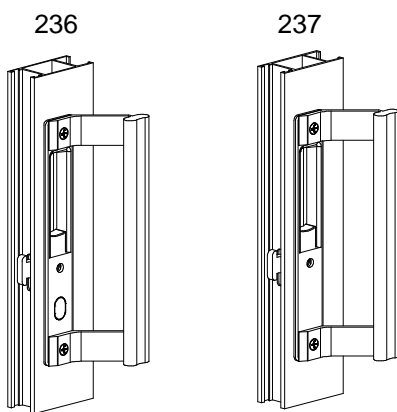

Peças # Part # Piezas # Pieces

Parafusos Ø3,9x16 zincados

Zinc steel screws Ø3,9x16
 Tornillos de acero zinc Ø3,9x16
 Vis en acier zinc Ø3,9x16

Materiais # Materials # Materiales # Matériels

Alumínio

Aluminium
 Aluminio
 Aluminium

Acabamento # Finishing # Acabados # Finitions

Lacado

Powder painting
 Lacado
 Laqué

Embalagem # Packaging #
 Empaquetado # Emballage



Qty: 20

Observações # Comments # Observaciones # Observations: Fecho de embutir não incluído # Sliding lock not included # Cierres de embutir no incluído # Fermeture latérale pas compris

© 2013 - ALUALPHA, Fabrico e Comercialização de Ferragens S.A. | Todos os direitos reservados | All rights reserved | Todos los derechos reservados | Tous droits réservés

Nota: O conteúdo desta folha técnica é puramente informativo. A instalação é feita com total responsabilidade do instalador. The content of this technical sheet is purely informative. The installation is done with total responsibility of the installer. A Alualpha reserva-se o direito de proceder, sem aviso prévio, a mudanças ou modificações técnicas dos produtos apresentados. The Alualpha reserves the right to proceed without notice, to changes or technical modifications of the products presented.