

Kits para ligação de abertura para o exterior
 Connection kits for exterior opening
 Kits para la conexión de apertura exterior
 Kits de connexion pour ouverture extérieur

DIVERSOS



**S6/7/8
 S9/11**

S 11

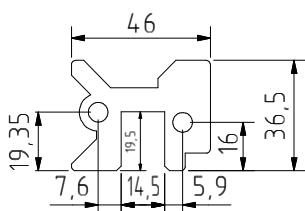

S 9

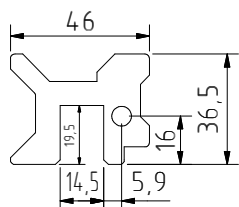

S 8

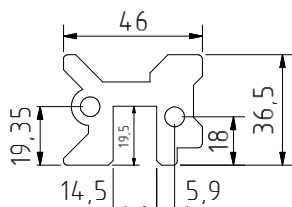

S 7

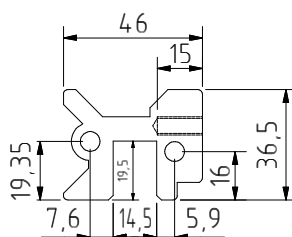
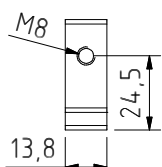

S 6

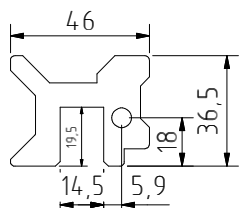

Pernos de ligação incluídos em todos os kits
 Connection pins included in all kits
 Tornillos de ligación incluídos em todos los kits
 Lien boulons compris en tous kits

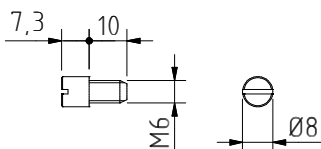

Maquinação e exemplo de aplicação
 Machining and application example
 Mecanizado y ejemplo de aplicación
 Usinage et exemple d'application

ALPHA

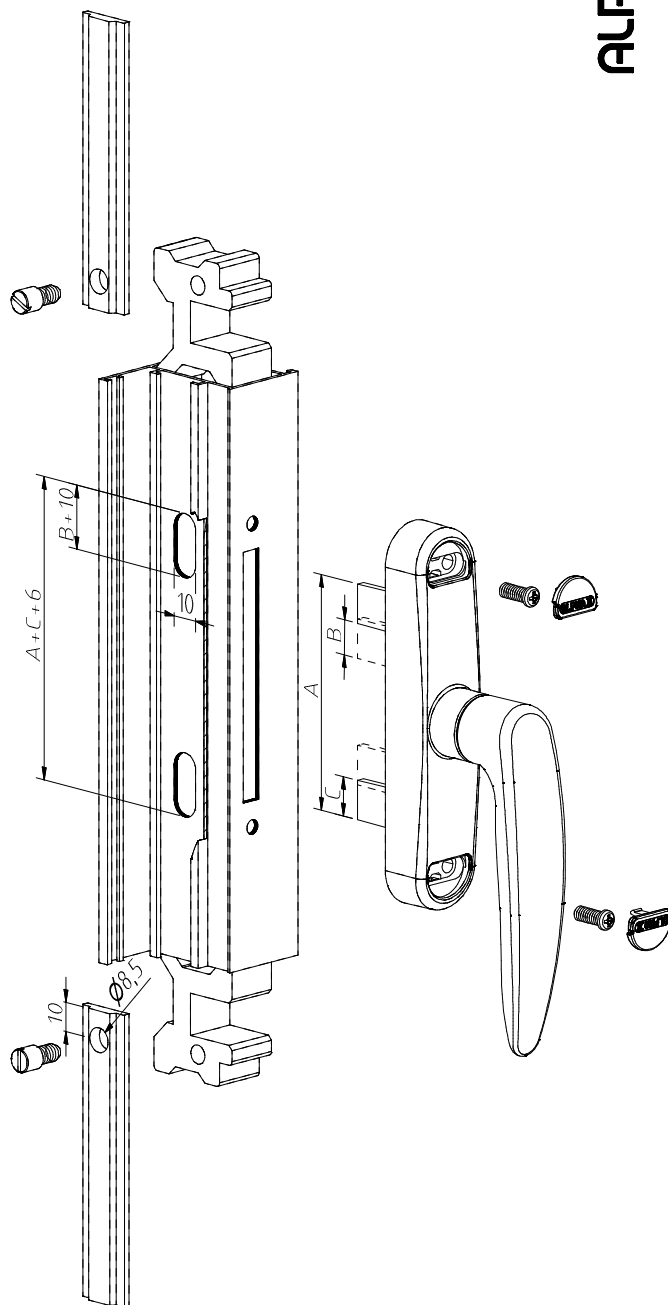

Peças # Part # Piezas # Pieces

Pernos de ligação M6x10 inox (S7)

Connection pins M6x10 in stainless steel (S7)
 Tornillos de ligación M6x10 de acero inox (S7)
 Lien boulons M6x10 en acier inox (S7)

Materiais # Materials # Materiales # Matériels

Nylon reforçado, latão zincado, inox

Nylon reinforced, zinc brass, stainless steel
 Nylon reforzado, latón zinc y acero inox
 Nylon renforcé, laiton zinc et acier inox

Acabamento # Finishing # Acabados # Finitions

Preto natural

Natural black
 Negro natural
 Noir naturelle

Embalagem # Packaging # Empaquetado # Emballage



Qty: 40

Observações # Comments # Observaciones # Observations: Cremone não incluída # Cremona not included # Cremona no incluido # Cremone pas compris

© 2013 - ALUALPHA, Fabrico e Comercialização de Ferragens S.A. | Todos os direitos reservados | All rights reserved | Todos los derechos reservados | Tous droits réservés

Nota: O conteúdo desta folha técnica é puramente informativo. A instalação é feita com total responsabilidade do instalador. The content of this technical sheet is purely informative. The installation is done with total responsibility of the installer. A Alualpha reserva-se o direito de proceder, sem aviso prévio, a mudanças ou modificações técnicas dos produtos apresentados. The Alualpha reserves the right to proceed without notice, to changes or technical modifications of the products presented.